

# Linear DVS2408/Dual 824 Program Sheet

- Enter Program**      1. Enter Master Code + TEST (1 Gong + 5 Beeps)  
                                  2. Enter Master Code Again + TEST (1 Gong + 5 Beeps, all active zones light)
- Exit Program**        Press OFF for 3 seconds
- Program Location**    Location + HOME + Enter new Value + AWAY (should hear 1 bing)  
                                  (To program 30 second Entry Delay press 25 + HOME + 30 + AWAY)
- Delete Location**     Location + HOME + AWAY (should hear 1 bing)
- Hardwire Zones**      (Hardware Zones can be any Zone Number)  
                                  301 + HOME + Zone (01 to 24) + AWAY (This Assigns Hardwire Loop 1 as Zone)  
                                  to  
                                  308 + HOME + Zone (01 to 24) + AWAY (This Assigns Hardwire Loop 8 as Zone)  
                                  (Once Hardwired Zone is enabled you don't learn it in, just set Zone type)
- Add Sensor**         Enter sensor number (01 to 24), zone light will flash, activate sensor  
                                  1 "Bing" = Program OK, 2 "Bings" = sensor already programmed in location  
                                  (If learning DX-10 keypad press and hold \* and do not program a zone type)
- Delete Sensor**       1. Enter sensor to remove (01 to 24), zone light will flash  
                                  2. Press TEST, 1 "Bing" will sound and zone light will turn off
- Set Zone Type**       1. Enter Sensor Number (01 to 24) DVS1200 (01 to 12)  
                                  2. Press HOME + Sensor type (1 to 10) + AWAY (keypad sounds 1 "Bing")  
                                  (do not program ANY zone type for DXS-10 keypad)
- Supervisory**         Zone Number + HOME + (16 or 17) + AWAY  
                                  Non-Supervised            16 (Panic Buttons/Remote Keypads)  
                                  Supervised                    17 (Doors, Smokes, Motions etc)  
                                  By default any wireless sensor added to system is supervised
- Defaulting Panel**     While in programming press 999 + TEST + 999 + TEST wait 10 seconds  
                                  Note: After defaulting press \* + New 4 to 5 Digit Master Code + OFF

<u>Loc</u>	<u>Description</u>	<u>          </u>	<u>Possible Entries</u>
01	Zone 01 Type		1 = Home Automation
02	Zone 02 Type		2 = Emergency
03	Zone 03 Type		3 = Silent Panic
04	Zone 04 Type		4 = Fire
05	Zone 05 Type		5 = Perimeter
06	Zone 06 Type		6 = Entry/Exit
07	Zone 07 Type		7 = Interior Motion
08	Zone 08 Type		8 = Chime (No Alarm)
09	Zone 09 Type		9 = 2- Button Arm/Disarm (Home Automation)
10	Zone 10 Type		10 = 2-Button Arm/Disarm (Use for Keyfob)
11	Zone 11 Type		11 = Environmental (Siren only, no Report)
12	Zone 12 Type		
13	Zone 13 Type		
14	Zone 14 Type		
15	Zone 15 Type		
16	Zone 16 Type		
17	Zone 17 Type		
18	Zone 18 Type		
19	Zone 19 Type		
20	Zone 20 Type		
21	Zone 21 Type		
22	Zone 22 Type		
23	Zone 23 Type		
24	Zone 24 Type		
25	Entry Delay	30	1 to 255 seconds
26	Exit Delay	60	1 to 255 seconds
30	Burg Siren Time	5	1 to 30 minutes
31	Emergency Siren Time	5	1 to 30 minutes
32	Fire Siren Time	5	1 to 30 minutes
40	Automation Output Time	5	0 to 2500 Seconds 0 = Toggle On/Off
50	Keyfob Arming Mode	3	2 = Home Mode 3 = Away Mode
51	Keyfob Disarming Mode	0	0 = OFF Mode 1=Chime Mode

## Linear DVS2408/Dual 824 Program Sheet

61	Entry Delay Beeps	1	0 = OFF 1 = ON
62	Exit Delay Beeps	1	0 = OFF 1 = ON
63	Burglary Alarm	0	0 = Audible 1 = Silent
64	Emergency Alarm	0	0 = Audible 1 = Silent
65	Quick Arming	0	0 = OFF 1 = ON
66	Auto Restore	0	0 = OFF 1 = ON
67	Auto Bypass of Open Zones	0	0 = OFF 1 = ON
68	Automation Mode During Alarm (Enabled by Function 72)	0	0 = Flash 1 = Steady
69	Automation Bing Tone	1	0 = NO 1 = Yes
70	Remote Arm/Disarm Chirp	1	0 = No Chirps 1 = Chirps
71	Automation Flashes after Alarm	0	0 = Standard 1 = Flashing after Alarm
72	Automation Active during Alarm	0	0 = Standard 1 = Automation Active
73	Automation On while Armed	0	0 = Standard 1 = On while Armed
74	Automation On during Entry/Exit	0	0 = Standard 1 = ON during Entry/Exit
75	Automation Polarity	1	0 = + when OFF 1 = + when ON
76	2-Way Audio (must have VB2 - VB3 Installed)	2	0 = None 1 = Listen <u>2 = 2-Way Manual</u> 3 = 2-way Full Duplex
78	Voice Enabled (must have VB2 - VB3 Installed)	1	0 = Voice Response Disabled 1 = Voice Response Enabled
86	Call Routing	1	0 = All to Primary or Secondary 1 = Alarms to Primary or Secondary others to Supervisory Number
87	Remote Access Password	9     8     7     6     5     4	
88	Account Number (0 to 9 only)		
89	Primary Phone Number	Up to 20 digits (A Key = 1 sec pause)	
90	Secondary Phone Number	Up to 20 digits	
91	Supervisory Phone Number	Up to 20 digits	
92	Duress Code		1 to 5 digits
93	Secondary User Code 1		1 to 5 digits
94	Secondary User Code 2		1 to 5 digits
95	Secondary User Code 3		1 to 5 digits
96	Secondary User Code 4		1 to 5 digits
97	Secondary User Code 5		1 to 5 digits
98	Secondary User Code 6		1 to 5 digits
99	Installer Code		1 to 5 digits

## Linear DVS2408/Dual 824 Program Sheet

100	Remote Programming Lockout (Downloading Enable)	0	0 = Unlock (Enabled) 1 = Lock (Disabled)
101	Swinger Shutdown	0	0 = OFF 1 = 5 Alarms until Swinger
103	Dialing Delay	0	0 = No Delay 1 = 15 Second Delay
104	Dialing Method	0	0 = Tone 1 = Pulse
105	Report Format	1	0 = 4/2 1 = Ademco Contact ID
107	Communicator Enabled	1	0 = Disabled 1 = Enabled
108	Report System Trouble	1	0 = NO 1 = Yes
110	Report Force Arming	0	0 = NO 1 = Yes
113	Point ID Reporting for 4/2 Format	1	0 = NO 1 = Yes

Below are 4/2 format signals, normally leave alone, enter 00 to disable

201	General Fire Panic Report Code	1	0 to 99
202	General Emergency Report Code	2	0 to 99
203	General Silent Panic Report Code	3	0 to 99
204	General Burglary Report Code	4	0 to 99
205	General Trouble Report Code	6	0 to 99
210	Sensor 1 Alarm Report Code	11	0 to 99
211	Sensor 2 Alarm Report Code	12	0 to 99
212	Sensor 3 Alarm Report Code	13	0 to 99
213	Sensor 4 Alarm Report Code	14	0 to 99
214	Sensor 5 Alarm Report Code	15	0 to 99
215	Sensor 6 Alarm Report Code	16	0 to 99
216	Sensor 7 Alarm Report Code	17	0 to 99
217	Sensor 8 Alarm Report Code	18	0 to 99
218	Sensor 9 Alarm Report Code	19	0 to 99
219	Sensor 10 Alarm Report Code	20	0 to 99
220	Sensor 11 Alarm Report Code	21	0 to 99
221	Sensor 12 Alarm Report Code	22	0 to 99
222	Sensor 13 Alarm Report Code	23	0 to 99
223	Sensor 14 Alarm Report Code	24	0 to 99
224	Sensor 15 Alarm Report Code	25	0 to 99
225	Sensor 16 Alarm Report Code	26	0 to 99
226	Sensor 17 Alarm Report Code	27	0 to 99
227	Sensor 18 Alarm Report Code	28	0 to 99
228	Sensor 19 Alarm Report Code	29	0 to 99
229	Sensor 20 Alarm Report Code	30	0 to 99
230	Sensor 21 Alarm Report Code	31	0 to 99
231	Sensor 22 Alarm Report Code	32	0 to 99
232	Sensor 23 Alarm Report Code	33	0 to 99
233	Sensor 24 Alarm Report Code	34	0 to 99
234	Sensor 1 Trouble Report Code	41	0 to 99
235	Sensor 2 Trouble Report Code	42	0 to 99
236	Sensor 3 Trouble Report Code	43	0 to 99
237	Sensor 4 Trouble Report Code	44	0 to 99
238	Sensor 5 Trouble Report Code	45	0 to 99
239	Sensor 6 Trouble Report Code	45	0 to 99
240	Sensor 7 Trouble Report Code	47	0 to 99
241	Sensor 8 Trouble Report Code	48	0 to 99
242	Sensor 9 Trouble Report Code	49	0 to 99
243	Sensor 10 Trouble Report Code	50	0 to 99
244	Sensor 11 Trouble Report Code	51	0 to 99
245	Sensor 12 Trouble Report Code	52	0 to 99
246	Sensor 13 Trouble Report Code	53	0 to 99
247	Sensor 14 Trouble Report Code	54	0 to 99
248	Sensor 15 Trouble Report Code	55	0 to 99
249	Sensor 16 Trouble Report Code	56	0 to 99

# Linear DVS2408/Dual 824 Program Sheet

250	Sensor 17 Trouble Report Code	57	0 to 99
251	Sensor 18 Trouble Report Code	58	0 to 99
252	Sensor 19 Trouble Report Code	59	0 to 99
253	Sensor 20 Trouble Report Code	60	0 to 99
254	Sensor 21 Trouble Report Code	61	0 to 99
255	Sensor 22 Trouble Report Code	62	0 to 99
256	Sensor 23 Trouble Report Code	63	0 to 99
257	Sensor 24 Trouble Report Code	64	0 to 99
258	Force Arming Report Code	65	0 to 99
259	Duress Report code	66	0 to 99
261	KP Fire Report Code	68	0 to 99
262	KP Emergency (Police) Report Code	69	0 to 99
263	System Test/Cancel Report Code	70	0 to 99
264	System Low Bat Restore Code	71	0 to 99
266	System Low Bat Report Code	73	0 to 99

Hardwired loops must be assigned a Zone from 01 to 24

301	Hardwire Zone 1 Assignment		01 to 24
302	Hardwire Zone 2 Assignment		01 to 24
303	Hardwire Zone 3 Assignment		01 to 24
304	Hardwire Zone 4 Assignment		01 to 24
305	Hardwire Zone 5 Assignment		01 to 24
306	Hardwire Zone 6 Assignment		01 to 24
307	Hardwire Zone 7 Assignment		01 to 24
308	Hardwire Zone 8 Assignment		01 to 24
999	Default System	999 + TEST + 999 + TEST	

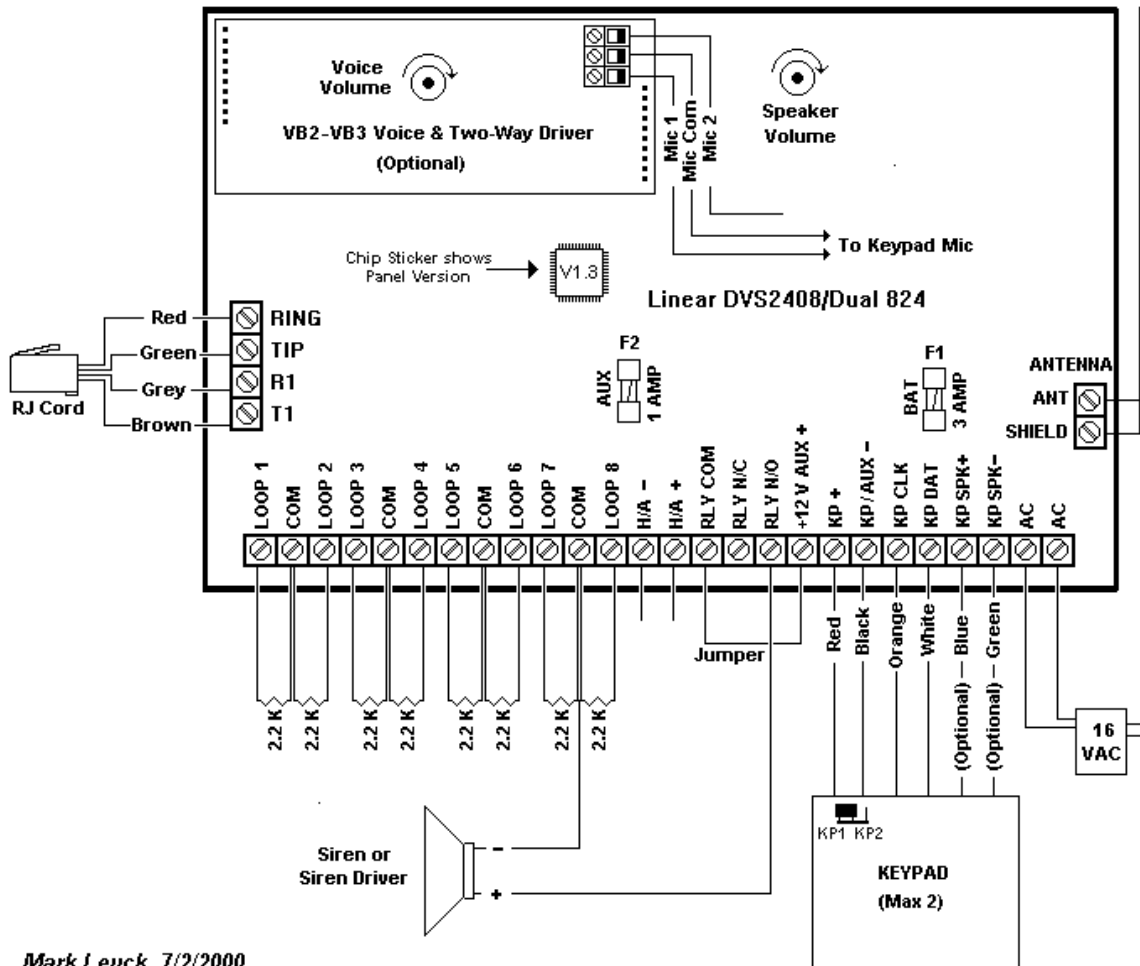

Mark Leuck 7/2/2000

# Linear DVS2408/Dual 824 Program Sheet

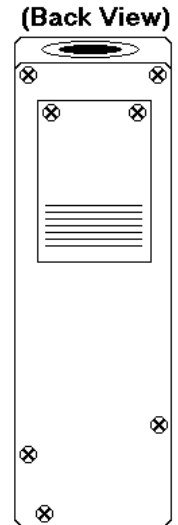
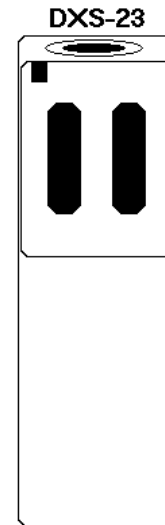
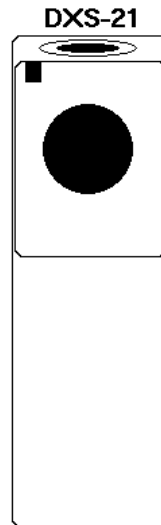
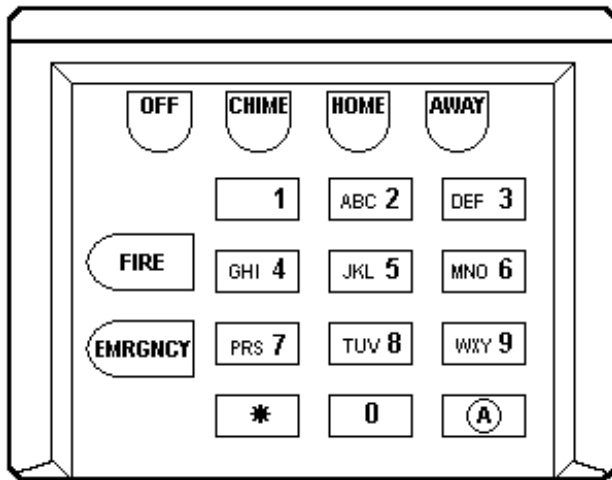

Insert Screwdriver  
pop cover off

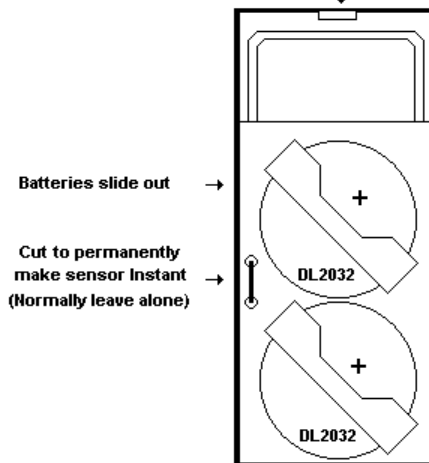

Remove Screw to slide  
Battery Tray out

2 - DL2032  
Lithium  
Flat Batteries

Add as Zone Type 09 or 10, program Arming Modes in Locations 50 and 51  
Top Button is always a Panic

## DXS-31 Door/Window Switch

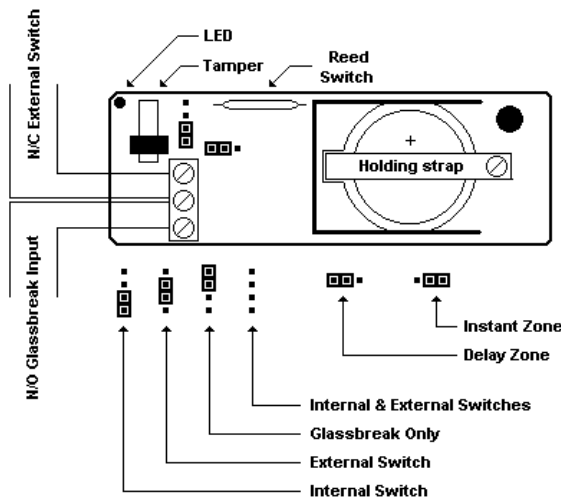

2 - DL2032  
Lithium  
Flat Batteries

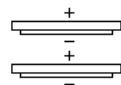

# Linear DVS2408/Dual 824 Program Sheet

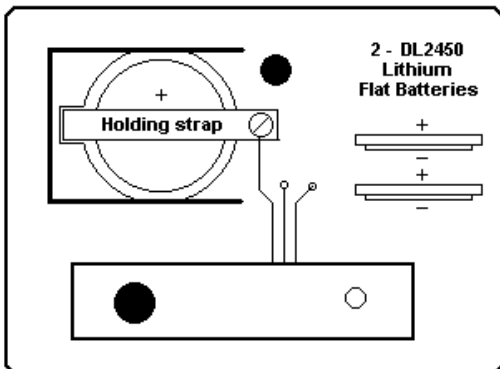
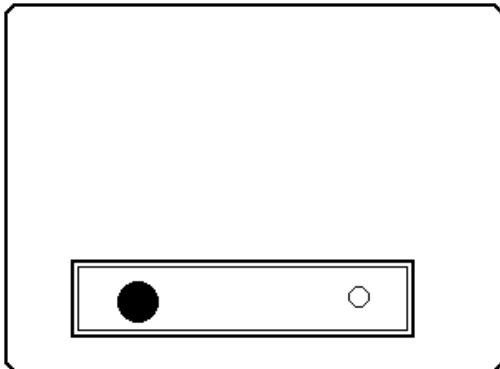
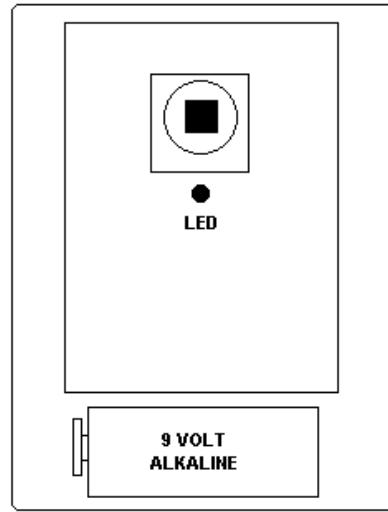
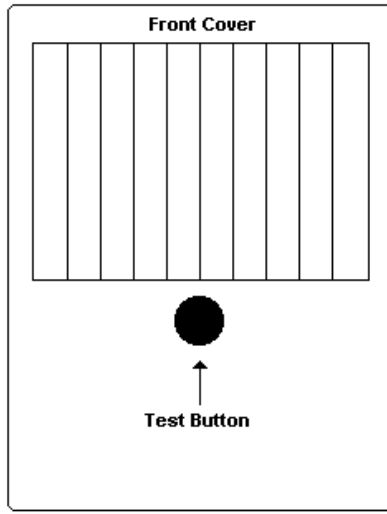

1 Button Arms  
1 Button Disarms

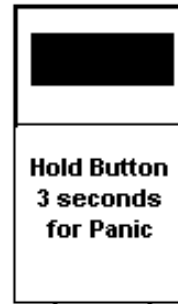

Remove Screws to Open  
(Be VERY Careful)

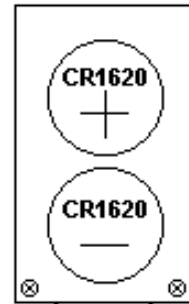

# Monitronics Monitoring and Service: 1-800-447-9239

## Linear DVS2408/Dual 824 Quick Reference Guide

Arm Away	User Code + AWAY
Arm Home	User Code + HOME, all interior motions will be disarmed
Disarming / Silencing Alarms	User Code + OFF If turning off an alarm press ★ to clear display
Instant Doors	User Code + INSTANT (7) to arm system Entry/Exit doors will arm instant and motion detectors will be bypassed (display will show both STAY and INSTANT)
Zone Bypassing	Open Zone to bypass Arm system, system will give protest beeps Arm system again
User Codes	Any User Code can change itself or any other User Code 1. Enter User Code + TEST 2. Enter User Code + TEST again 3. Enter User (93 to 98 + HOME) 4. Enter new 3 to 5-digit User Code 5. Press AWAY to save 6. Press OFF to exit  To delete a User Code follow above steps but press TEST instead of a new User Code (Keypad should give 1 Gong + 4 Beeps) (Keypad should give 1 Gong + 5 Beeps) (1 Beep if successful, Buzz if incorrect)
Door Chimes	Enter User Code + CHIME or press CHIME for 2 seconds
Test Sensors	1. Enter User Code + Test 2. Display lights will flash on each untested Sensor 3. Activate sensor, Zone light will turn off for that Sensor 4. Test finishes when all Sensor are tested (Keypad should give 1 Gong + 4 Beeps)